



AYRTON

AIR CONDITIONING

AYM-07P

Local airconditioner

Content

Operation Notices

The Refrigerant	1
Safety Warning	2
Operation Environment	3
Part's Name	4

Operation Guide

Operation Introduction for Control Panel	5
Buttons on Remote Controller	7
Introduction for Icons on Display Screen	7
Introduction for Buttons on Remote Controller	8
Function Introduction for Combination Buttons	12
Operation Guide	13
Replacement of Batteries in Remote Controller	13

Maintenance

Clean and Maintenance	14
-----------------------------	----

Malfunction

Malfunction Analysis	16
----------------------------	----

Installation Notice

Installation Precaution	19
Preparation before Installation	21

Installation

Install Wire Hook	22
Removing Collected Water	23
Installation in a double-hung sash window(Optional)	25
Installation in a sliding sash window(Optional)	28
Installation and Disassembly of Heat Discharge Pipe	31

Attached Sheet

Operation Test	34
Electric Schematic Diagram	34
Specialist's Manual	35

This appliance is not intended for use by persons (including children) with reduced physical, sensory or mental capabilities, or lack of experience and knowledge, unless they have been given supervision or instruction concerning use of the appliance by a person responsible for their safety.

Children should be supervised to ensure that they do not play with the appliance.



This marking indicates that this product should not be disposed with other household wastes throughout the EU. To prevent possible harm to the environment or human health from uncontrolled waste disposal, recycle it responsibly to promote the sustainable reuse of material resources. To return your used device, please use the return and collection systems or contact the retailer where the product was purchased. They can take this product for environmental safe recycling.



Appliance filled with flammable gas R290.



Before install and use the appliance, read the owner's manual first.



Before install the appliance, read the installation manual first.



Before repair the appliance, read the service manual first.

The Refrigerant

- To realize the function of the air conditioner unit, a special refrigerant circulates in the system. The used refrigerant is the fluoride R290, which is specially cleaned. The refrigerant is flammable and inodorous. Furthermore, it can lead to explosion under certain conditions.
- Compared to common refrigerants, R290 is a nonpolluting refrigerant with no harm to the ozone layer. The influence upon the greenhouse effect is also lower. R290 has very good thermodynamic features which lead to a really high energy efficiency. The units therefore need a less filling.
- Please refer to the nameplate for the charging quantity of R290.

WARNING :

- Appliance filled with flammable gas R290.
- Appliance shall be installed, operated and stored in a room with a floor area larger than 11 m².
- The appliance shall be stored in a room without continuously operating ignition sources . (for example: open flames, an operating gas appliance or an operating electric heater.)
- The appliance shall be stored in a well-ventilated area where the room size corresponds to the room area as specified for operation.
- The appliance shall be stored so as to prevent mechanical damage from occurring.
- Ducts connected to an appliance shall not contain an ignition source.
- Keep any required ventilation openings clear of obstruction.
- Do not pierce or burn.
- Be aware that refrigerants may not contain an odour.
- Do not use means to accelerate the defrosting process or to clean, other than those recommended by the manufacturer.
- Servicing shall be performed only as recommended by the manufacturer.
- Should repair be necessary, contact your nearest authorized Service Centre. Any repairs carried out by unqualified personnel may be dangerous.
- Compliance with national gas regulations shall be observed.
- Read specialist's manual.

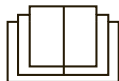

Safety Warning

- This appliance can be used by children aged from 8 years and above and persons with reduced physical, sensory or mental capabilities or lack of experience and knowledge if they have been given supervision or instruction concerning use of the appliance in a safe way and understand the hazards involved.
- Children shall not play with the appliance.
- Cleaning and user maintenance shall not be made by children without supervision.
- Before operation, please confirm whether power specification complies with that on nameplate.
- Before cleaning or maintaining the air conditioner, please turn off air conditioner and pull out the power plug.
- Make sure the power cord hasn't been pressed by hard objects.
- Do not pull or drag the power cord to pull out the power plug or move the air conditioner.
- Do not insert or pull out the power plug with wet hands.
- Please use the grounded power. Make sure the grounding is reliable.
- If the supply cord is damaged, it must be replaced by the manufacturer or its service agent or a similarly qualified person in order to avoid a hazard.
- If abnormal condition occurs (e.g. burned smell), please disconnect power at once and then contact local dealer.
- When nobody is taking care of the unit, please turn it off and remove the power plug or disconnect power.
- Do not splash or pour water on air conditioner. Otherwise, it may cause short circuit or damage to air conditioner.
- If drainage hose is used, ambient temperature can't be lower than 0 °C . Otherwise, it will cause water leakage to air conditioner.
- Prohibit operating heating equipment around the air conditioner.
- Prohibit operating the unit in the bathroom or laundry room.
- Far away from fire source, inflammable and explosive objects.
- Children and disabled people are not allowed to use the portable room air conditioner without supervision.
- Keep children from playing or climbing on the air conditioner.
- Do not put or hang dripping objects above the air conditioner.
- Do not repair or disassemble the air conditioner by yourself.
- Prohibit inserting any objects into the air conditioner.

Safety Warning

- Do not use an extension cord.
- Do not through sundries into the air duct. If there are sundries get into the air duct, please contact the professionals to deal with it.

Operation Environment

- The air conditioner must be operated within the temperature range: 16°C ~ 35°C.
- The appliance is for indoor use only.
- The appliance must be positioned so that the plug is accessible.
- This air conditioner can only be used for family, not for commercial industry.
- Reserved space around the air conditioner should be 12"(30cm) at least.
- Do not operate the air conditioner at humid environment.
- Please keep air inlet and air outlet clean, no obstacles.
- During operation, close doors and windows to improve cooling effect.
- Please put the air conditioner at smooth and flat ground for operation to avoid noise and vibration.
- This air conditioner is equipped with castors. Castors should slide at smooth and flat ground.
- Prohibit inclining or turning over the air conditioner. If there's abnormality, please disconnect power immediately and contact dealer.
- Avoid direct sunshine.

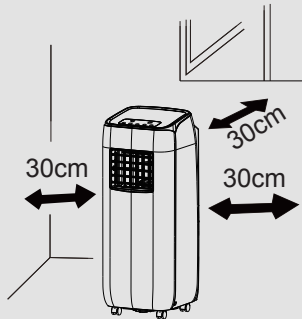

Note:

Graphics in this manual are only for reference. Please refer to actual products for specific details.

Part's Name

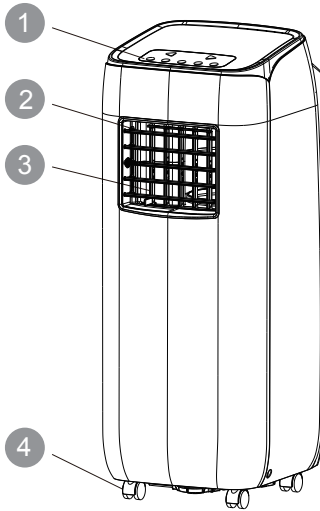

- 1 Controller panel
- 2 Guide louver
- 3 Swing louver
- 4 Castor
- 5 Filter
- 6 Joint
- 7 Heat discharge pipe
- 8 Window adapter
- 9 Plug of power cord
- 10 Wire-fixing hook

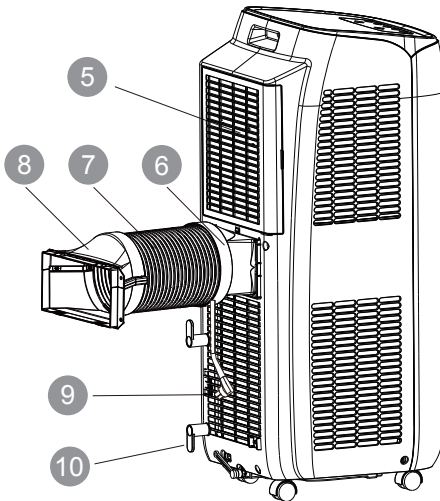

Remote controller

NOTICE:

Heat discharge pipe and other installation accessories can't be discarded.

Operation Introduction for Control Panel

Name of control panel

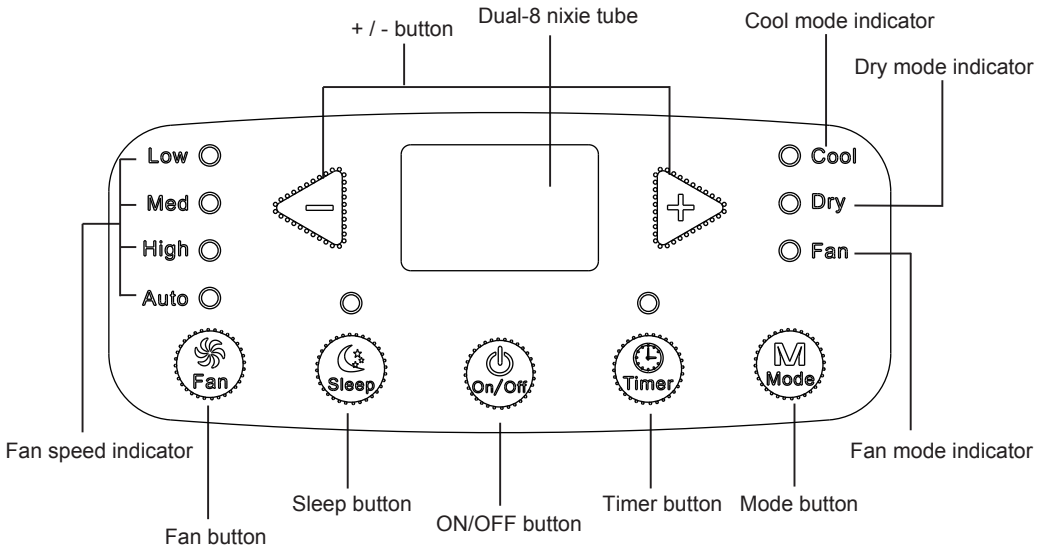

Operation of control panel

Note:

- After putting through the power, the air conditioner will give out a sound. After that, you can operate the air conditioner by the control panel.
- Under ON status, after each pressing of the button on control panel, the air conditioner will give out a sound. Meanwhile, corresponding indicator on control panel will be bright.
- Under OFF status, dual-8 nixie tube on control panel won't display.
Under ON status, dual-8 nixie tube on control panel will display set temperature under cooling mode, while it won't display under other modes.

1 ON/OFF button

Pressing this button can turn on or turn off the air conditioner.

2 + / - button

Under cooling mode, press "+" or "-" button to increase or decrease set temperature by 1°C. Set temperature range is 16°C~30°C. Under auto, drying or fan mode, this button is invalid.

Operation Introduction for Control Panel

3 Mode button

Press this button and the mode will circulate according to below sequence:

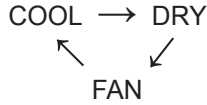

COOL: Under this mode, cooling mode indicator is bright. Dual-8 nixie tube displays set temperature. Temperature setting range is 16°C~30°C.

DRY: Under this mode, drying mode indicator is bright. Dual-8 nixie tube won't display.

FAN: Under this mode, the air conditioner only blow fan. Fan indicator is bright. Dual-8 nixie tube won't display.

4 Fan button

Press this button and the fan speed will circulate as "low speed→ medium speed → high speed→ auto fan→ low speed".

5 Timer

Press timer button to enter into timer setting mode. Under this mode, press " + " or " - " button to adjust the timer setting. Timer setting will increase or decrease 0.5 hour by pressing " + " or " - " button within 10 hours, while timer setting will increase or decrease 1 hour by pressing " + " or " - " button beyond 10 hours. After timer setting is finished, the unit will display temperature if there's no operation for 5s. If timer function is started up, the upper indicator will keep the display status. Others, it won't be displayed. Under timer mode, press timer button again to cancel timer mode.

6 Sleep

Press sleep button to enter into sleep mode. If the controller operates at cooling mode, after sleep mode is started up, preset temperature will increase by 1°C within 1 hour ;preset temperature will increase by 2°C within 2 hours and then the unit will operate at this temperature all the time; Sleep function is not available for fan mode, drying mode. If sleep function is started up, the upper indicator will keep the display status. Others, it won't be displayed.

Buttons on remote controller

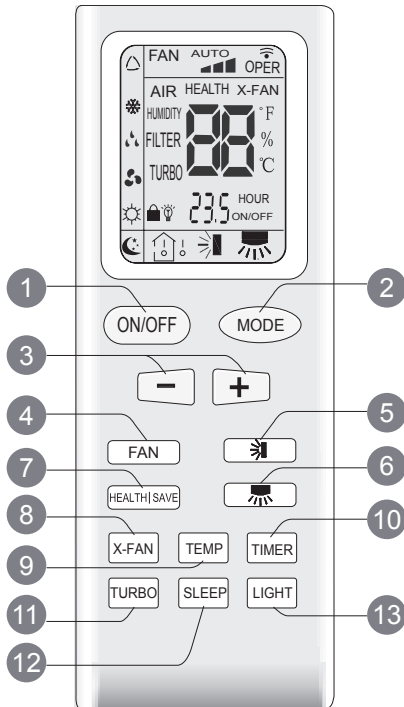

- 1 ON/OFF button
- 2 MODE button
- 3 +/- button
- 4 FAN button
- 5 button
- 6 button
- 7 HEALTH|SAVE button
- 8 X-FAN button
(Note: X-FAN is same with BLOW)
- 9 TEMP button
- 10 TIMER button
- 11 TURBO button
- 12 SLEEP button
- 13 LIGHT button

Introduction for icons on display screen

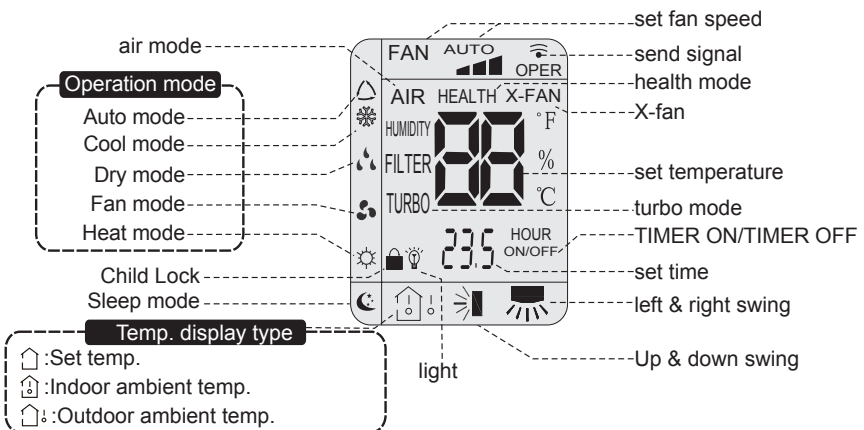

Introduction for buttons on remote controller

Note:

- This is a general use remote controller, it could be used for the air conditioners with multifunction; For some function, which the model doesn't have, if press the corresponding button on the remote controller that the unit will keep the original running status.
- After putting through power, air conditioner will give out a sound and operation indicator "⏻" is ON (red indicator, the colour is different for different models). You can operate the air conditioner through the remote controller.
- At ON status, after each pressing button on remote controller, the signal icon "📶" on remote controller will flash once. Air conditioner will give out a sound, which indicates the signal has been sent to air conditioner.
- At OFF status, display screen on remote controller displays set temperature. At on status, display screen on remote controller displays the corresponding startup function's icon.

1 ON/OFF button

Press this button to turn on the unit. Press this button again to turn off the unit.

2 MODE button

Press this button can select your required operation mode.



- After selecting auto mode, air conditioner will operate automatically according to ambient temperature. Set temperature can't be adjusted and also can't be displayed. Press "FAN" button can adjust fan speed. Press "↔" button can adjust swing angle.
- After selecting cool mode, air conditioner operates under cool mode. Cool indicator "❄️" on indoor unit is ON (This indicator is not available for some models). You can press "+" or "-" button to adjust set temperature. Press "FAN" button can adjust fan speed. Press "↔" button can adjust swing angle.
- After selecting dry mode, air conditioner operates under dry mode at low speed. Dry indicator "💧" on indoor unit is ON (This indicator is not available for some models). Under dry mode, fan speed can't be adjusted. Press "↔" button to adjust swing angle.
- After selecting fan mode, air conditioner operates only under fan mode, All mode indicators on indoor unit is OFF. Operation indicator is ON.(This indicator is not available for some models). Press "FAN" button can adjust fan speed. Press "↔" button to adjust swing angle.
- After selecting heat mode, air conditioner operates under heat mode. Heat indicator "☀️" on indoor unit is ON(This indicator is not available for some models). You can press "+" or "-" button to adjust set temperature. Press "FAN" button to adjust fan speed. Press "↔" button to adjust swing angle. (Cooling only unit can't receive the signal for heating mode.)

Introduction for buttons on remote controller

Note:

For preventing cold wind, after starting up heating mode, indoor fan will blow fan after delaying 1-5min. (Details time is decided by indoor ambient temperature)
Temperature setting range on remote controller: 16°C -30°C . Fan speed setting range: auto, low speed, medium speed and high speed.

3 "+" or "-" button

- After each pressing of "+" or "-" button, it can increase or decrease set temperature 1°C . Hold "+" or "-" button, 2s later, set temperature on remote controller will change quickly. After reaching to your required time, loosen the button. Temperature indicator on indoor unit will also change accordingly. (Temperature can't be adjusted under auto mode)
- Under TIMER ON, TIMER OFF or Clock setting, you can press "+" or "-" button to adjust time. (Refer to TIMER button for details)

4 FAN button

Pressing this button can set fan speed circularly as: auto (AUTO), low(▲), medium(▲▲), high(▲▲▲).

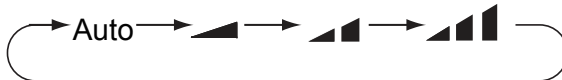

Note:

- Under AUTO Speed, IDU fan motor will adjust the fan speed (high, medium or low speed) according to ambient temperature.
- Fan speed under dry mode is low speed.

5 ㉞ button

- Press this button to start or stop up & down swing function. The remote controller defaults to simple swing condition.
- Press + button and ㉞ button at the same time at unit OFF to switch between simple swing and static swing; ㉞ blinks for 2 seconds.
- In static swing condition, pressing ㉞ button, the swing angle of up & down louver changes as below:

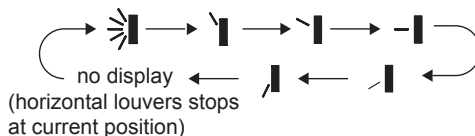

- If the unit is turned off during swing operation, the louver will stop at present position.



Introduction for buttons on remote controller

Note:

When selecting "↔" with remote controller, it's auto swing. Horizontal louver of air conditioner will swing up&down automatically at the maximum angle.

When selecting "┌", "┐", "└", "┑" with remote controller, it's the fixed position swing. Horizontal louver of air conditioner will stop at that position as shown by the icon to swing.

6 button

- Press this button to start or stop left & right swing function. The remote controller defaults to simple swing condition.
- Press + button and  button at the same time at unit OFF to switch between simple swing and static swing;  blinks for 2 seconds.
- In static swing condition, pressing  button, the swing angle of left & right louver changes as below:

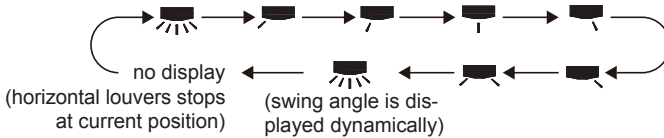

- If the unit is turned off during swing operation, the louver will stop at present position.
- When selecting "↔" with remote controller, it's auto swing. Horizontal louver of air conditioner will swing left&right automatically at the maximum angle.
- When selecting "┌", "┐", "└", "┑" with remote controller, it's the fixed position swing. Horizontal louver of air conditioner will stop at that position as shown by the icon to swing.
- When selecting "⊙" (swing angle is displayed dynamically), it's the circulating swing. Horizontal louver of air conditioner will swing circularly according to the angle as shown by the icon.

Note: There is no this function for some units. If press this key, the main unit will click, but it also runs under original status.

7 HEALTH|SAVE button

HEALTH FUNCTION:

After pressing HEALTH button, remote controller will switch circularly as below: "HEALTH" → "AIR" → "AIR HEALTH" → "no display"

- When selecting "HEALTH" by remote controller, HEALTH function will be started up.
- When selecting "AIR" by remote controller, AIR function will be started up.
- When selecting "AIR HEALTH", AIR and HEALTH function will be started up.
- When there's no display on remote controller, AIR and HEALTH function will be turned off.
- AIR function is applicable for some models.
- HEALTH function is applicable for some models.

Introduction for buttons on remote controller

SAVE function:

Under cool mode, press SAVE button and the unit will operate under SAVE mode. Dual-8nixie tube on remote controller displays "SE". Air conditioner will operate at auto speed. Set temperature can't be adjusted. Press SAVE button again to exit SAVE mode. Air conditioner turn back to original set speed and set temperature.

8 X-FAN button

After pressing this button under cooling or dry mode, remote controller displays the character of "X-FAN" and X-FAN function is started up. Press this button again to cancel X-FAN function. The character of "X-FAN" will disappear.

Note:

- After starting up X-FAN function, when turning off the unit, indoor fan will continue to operate for a while at low speed to dry the residual water inside the indoor unit.
- When the unit operates under X-FAN mode, press "X-FAN" button can turn off X-FAN function. Indoor fan stops operation immediately.

9 TEMP button

Press this button can see indoor set temperature, indoor ambient temperature or outdoor ambient temperature on indoor unit's display. Temperature is set circularly by remote controller as below:

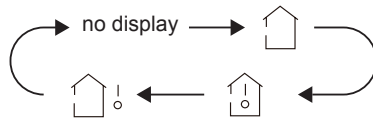

- When selecting "🏠" by remote controller or no display, temperature indicator on indoor unit displays set temperature.
- When selecting "🏠" by remote controller, temperature indicator on indoor unit displays indoor ambient temperature.
- When selecting "🏠!" by remote controller, temperature indicator on indoor unit displays outdoor ambient temperature.

Note:

- Outdoor ambient temperature display may can't be selected for some models. When indoor unit receives "🏠!" signal, it displays indoor set temperature.
- Only for the model whose indoor unit has dual-8 display.

10 TIMER button

At ON status, press this button once can set TIMER OFF. The character of HOUR and OFF will flash. Press "+" or "-" button within 5s can adjust the time of TIMER ON. After each pressing of "+" or "-" button, time will increase or decrease half an

Introduction for buttons on remote controller

hour. When holding "+" or "-" button, 2s later, the time will change quickly until to reach to your required time. After that, press "TIMER" button to confirm it. The character of HOUR and OFF won't flash again.

Cancel TIMER OFF: Press "TIMER" button again under TIMER OFF status.

- At OFF status, press this button once can set TIMER ON. Please refer to TIMER off for detailed operation.

Cancel TIMER ON: Press "TIMER" button again under TIMER ON status.

Note:



- Time setting range: 0.5-24 hours.
- Time interval between two operations can't exceed 5s. Otherwise, remote controller will exit the setting status automatically.

11 TURBO button



When pressing this button under cooling or heating mode, air conditioner will enter into quick cooling or quick heating mode. The character of "TURBO" is displayed on remote controller. Press this button again to exit turbo function and the character of "TURBO" will be disappeared on remote controller.

12 SLEEP button

Press this button under cooling, heating mode can start up sleep function.



" icon will be displayed on remote controller. Press this button again to cancel sleep function. " icon on remote controller will be displayed.

13 LIGHT button

Press this button can turn off the light for indoor unit's display. " icon on remote controller will disappear. Press this button again to turn on the light for indoor unit's display. " icon on remote controller will be displayed.

Function introduction for combination buttons

Child lock function

Press "+" and "-" buttons simultaneously can turn on or turn off child lock function. When child lock function is started up, " icon will be displayed on remote controller. If operate remote controller, " icon will flash three times, while remote controller won't send signal.

Switchover function for temperature display

After turning off the unit by remote controller, press "-" button and "MODE" button simultaneously to switch between °C and °F.

Clean and Maintenance

Clean heat discharge pipe

Remove the heat discharge pipe from air conditioner, clean and dry it , and then reinstall it. (For the method of installation and removal , please refer to the instruction for "Installation and disassembly of heat discharge pipe").

Checking before use-season

1. Check whether air inlets and air outlets are blocked.
2. Check whether plug and socket are in good condition.
3. Check whether filter is clean.
4. Check whether batteries are installed in remote controller.
5. Check whether joint, window bracket and heat discharge pipe are installed tightly.
6. Check whether heat discharge pipe is damaged.

Checking after use-season

1. Disconnect power supply.
2. Clean filter and outer case.
3. Remove dust and sundries on the air conditioner.
4. Eliminate accumulated water in chassis (refer to the section of "Drainage way" for details).
5. Check whether window bracket is damaged or not. If yes, please contact dealer.

Long-time storage

If you don't use the air conditioner for a long time, please maintain it by following steps for good performance:

- Make sure there's no accumulated water in chassis and the heat discharge pipe is disassembled.
- Pull out the plug and wrap the power cord.
- Clean the air conditioner and pack it well to prevent dust.

Notice for recovery

- Many packing materials are recyclable materials. Please deal with them through local recycle bin.
- If you want to throw away the air conditioner, please contact local division or consultant service center for the correct disposal method.

Malfunction Analysis

Please check below items before asking for maintenance. If the malfunction still can't be eliminated, please contact local dealer or qualified professionals.

Phenomenon	Troubleshooting	Solution
Air conditioner can't operate	● Power failure?	● Wait after power recovery.
	● Is plug loose?	● Reinsert the plug.
	● Whether the air switch is tripped off or fuse is burnt?	● Ask professional person to replace air switch or fuse.
	● Is there's malfunction for the circuit?	● Ask professional person to replace circuit.
	● Whether the unit is restarted up after stopping immediately?	● Wait for 3min, and then turn on the unit again.
Poor cooling (heating)	● Is the power too low?	● Wait after voltage is resumed.
	● Whether the air filter is too dirty?	● Clean the air filter.
	● Whether the set temperature is proper?	● Adjust the temperature.
	● Whether door and window are closed?	● Close door and window.
Air conditioner can't receive signal from remote controller or remote controller is not sensible.	● Whether the unit is interfered seriously (such as static pressure, unstable voltage)?	● Please pull out the plug. Insert the plug after about 3min, and then turn on the unit.
	● Whether remote controller is within the receiving range?	● The receiving range of remote controller is 8m. Do not exceed this range.
	● Whether it's blocked by obstacles?	● Remove the obstacles.
	● Is sensitivity of remote controller low?	● Check the batteries of remote controller. If the power is low, please replace the batteries.
	● Whether there's fluorescence lamp in the room?	● Move the remote controller close to air conditioner. ● Turn off the fluorescence lamp and try it again.

Malfunction Analysis

Phenomenon	Troubleshooting	Solution
No air blowed out from air conditioner	<ul style="list-style-type: none"> • Whether air outlet or air inlet is blocked? 	<ul style="list-style-type: none"> • Eliminate the obstacles.
	<ul style="list-style-type: none"> • Under heating mode, whether indoor temperature ireaches set temperature? 	<ul style="list-style-type: none"> • The unit will stop blowing fan after reaching set temperature.
	<ul style="list-style-type: none"> • Whether heating mode is started up just now? 	<ul style="list-style-type: none"> • In order to prevent cold air, air conditioner will delay for a while to be started up, which is the normal phenomenon.
	<ul style="list-style-type: none"> • Whether evaporator is defrosted? (observe it by pulling out the filter) 	<ul style="list-style-type: none"> • It's the normal phenomenon. Air conditioner is defrosting. After defrosting is finished, it will resume operation.
Set temperature can't be adjusted.	<ul style="list-style-type: none"> • Whether the unit operates under auto mode? 	<ul style="list-style-type: none"> • Temperature can't be adjusted under auto mode.
	<ul style="list-style-type: none"> • Whether the required temperature exceeds the temperature setting range? 	<ul style="list-style-type: none"> • Temperature setting range: 16°C-30°C .
There's off flavour	<ul style="list-style-type: none"> • There's off-flavour source in the room, such as furniture, cigarette etc. 	<ul style="list-style-type: none"> • Eliminate the off-flavour source. • Clean the filter.
There's abnormal sound during operation	<ul style="list-style-type: none"> • Whether the unit is interfered by thunder, radio, etc? 	<ul style="list-style-type: none"> • Disconnect power, put through the power again, and then turn on the unit again.
You can heard water-flowing sound	<ul style="list-style-type: none"> • Whether the unit is turned on or turned off just now? 	<ul style="list-style-type: none"> • There's flowing sound of refrigerant inside the air conditioner, which is the normal phenomenon.
You can heard the sound of "PAPA"	<ul style="list-style-type: none"> • Whether the unit is turned on or turned off just now? 	<ul style="list-style-type: none"> • Heat expansion or shrinkage for the panel due to change of temperature, which cause friction sound.

Malfunction analysis

Malfunction code

ERROR CODE	Troubleshooting
F0	Please contact qualified professionals for service.
F1	Please contact qualified professionals for service.
F2	Please contact qualified professionals for service.
F4	Please contact qualified professionals for service.
E8	1. Check if the unit is under high-temperature and high-humidity environment; if ambient temperature is too high, power off the unit and then energize it for operation after the ambient temperature drops to 35°C below.
H3	2. Check if the evaporator and condenser are blocked by some objects; if yes, take away the objects, power off the unit and then energize it for operation.
H8	3. If the malfunction still occur, please contact our after-sales service center.
	1. Pour out the water inside chassis.
	2. If "H8" still exists, please contact professional person to maintain the unit.



WARNING

- If there're following phenomenon, please turn off the air conditioner and disconnect the power immediately, and then contact dealer immediately.
 - Power cord is overheating or damaged.
 - Abnormal sound during operation.
 - Off-flavor.
 - Water leakage
- Do not repair or refit the air conditioner by yourself.
- If operate the air conditioner under abnormal condition, it may cause malfunction, electric shock or fire hazard.

Installation Precaution



WARNING

- Observe all governing codes and ordinances.
- Do not use damaged or non-standard power cord.
- Be caution during installation and maintenance. Prohibit incorrect operation to prevent electric shock, casualty and other accidents.

Selection of installation location

Basic requirement

Installing the unit in the following places may cause malfunction. If it is unavoidable, please consult the local dealer:

1. The place with strong heat sources, vapors, flammable or explosive gas, or volatile objects spread in the air.
2. The place with high-frequency devices (such as welding machine, medical equipment).
3. The place near coast area.
4. The place with oil or fumes in the air.
5. The place with sulfureted gas.
6. Other places with special circumstances.

Requirement of air conditioner

1. Air inlet should be far away from obstacles and do not put any objects near air outlet. Otherwise, it will affect the radiation of heat discharge pipe.
2. Select a location where the noise and outflow air emitted by the outddor unit will not affect neighborhood.
3. Please try your best to keep far away from fluorescent lamp.
4. The appliance shall not be installed in the laundry.

Installation Precaution

Requirements for electric connection

WARNING:







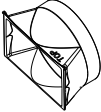
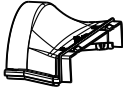

Safety precaution

1. Must follow the electric safety regulations when installing the unit.
2. According to the local safety regulations, use qualified power supply circuit.
3. For appliances with type Y attachment, the instructions shall contain the substance of the following. If the supply cord is damaged, it must be replaced by the manufacturer, its service agent or similarly qualified persons in order to avoid a hazard.
4. Properly connect the live wire, neutral wire and grounding wire of power socket.
5. Be sure to cut off the power supply before proceeding any work related to electricity and safety.
6. Do not put through the power before finishing installation.
7. The air conditioner is first class electric appliance. It must be properly grounded with specialized grounding device by a professional. Please make sure it is always grounded effectively, otherwise it may cause electric shock.
8. The yellow-green wire or green wire in air conditioner is grounding wire, which can't be used for other purposes.
9. The grounding resistance should comply with national electric safety regulations.
10. The appliance shall be installed in accordance with national wiring regulations.

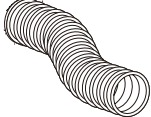
Preparation before Installation

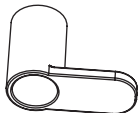





Note: check if the accessories are available before installation.

Accessory list

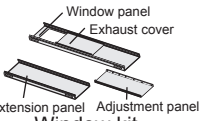

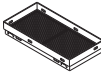

				
Joint	Window adapter(top)	Window adapter(bottom)	heat discharge pipe	Adapter
				
wire hook	screw	remote controller	battery (AAA 1.5V)	user's manual

Optional

Note: some models are without the following accessories.

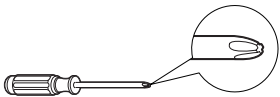
						
Window kit	Rain guard	Foam seal A	Foam seal B (adhesive type)	Insect guard net	screw	Bracket

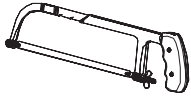
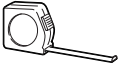
Tools needed for installation

		
cross screwdriver	straight screwdriver	saw
		
gauge	scissors	pencil

Install Wire Hook

- Assemble the wire hook at the back of the unit with screws (the direction of wire hook is as shown in following fig).

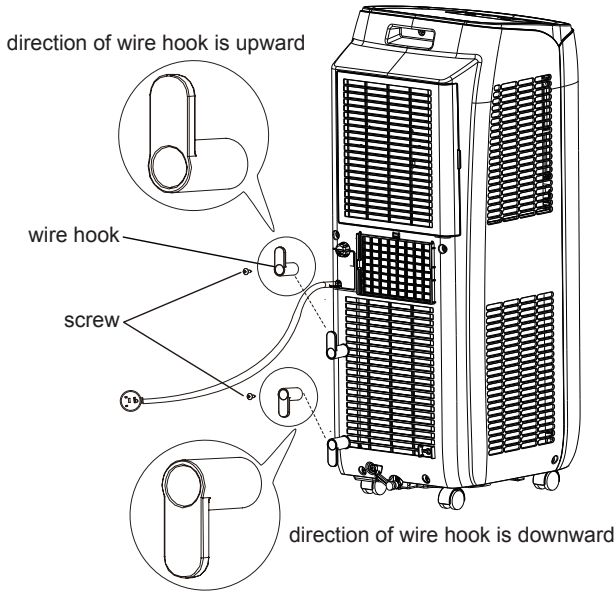

- Wind the power cord around the wire hook.

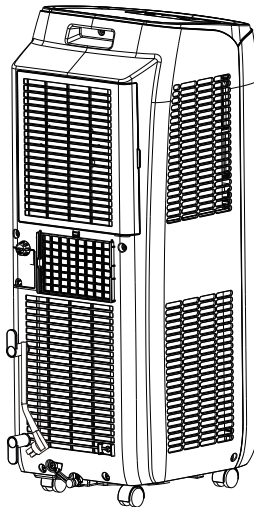

Removing Collected Water

There are 2 ways to remove collected water:

1 Use the continuous drainage option from the bottom hole

■ Drainage way as follows.

1. In Cool or Dry mode operating, the condensation water will be drained to the chassis.
2. When the chassis is full with water, the buzzer will give out 8 sounds and "H8" is displayed to remind user to discharge water, the unit will turn off about 2min later, and all buttons are invalid.

To empty the chassis, please follow the instructions below.

- Turn the unit off and unplug from the electrical outlet.
- Use a small pan or move the unit to a suitable place to drain the water.
- Remove the pre-installed drain cap from the unit.
- Drain the water into the small pan or a suitable place.
- Once draining is complete, re-install drain cap.
- Press ON/OFF button to restart the unit.

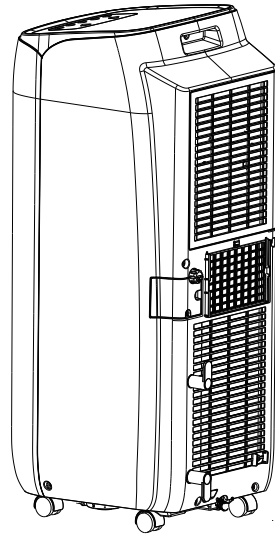
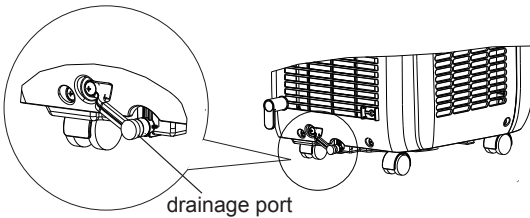

Removing Collected Water

2 Use the continuous drainage option from the middle hole

Note: Water can be automatically emptied into a floor drain by attaching 14mm inner diameter hose (not included).

1. Remove the continuous drain cap 1 by turning it counter clockwise then remove the rubber stopper 2 from the spout.

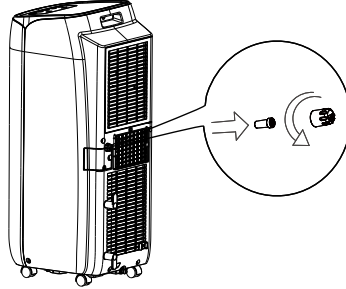

2. Screw the drain connector to (included in the package) the spout by turning clockwise.

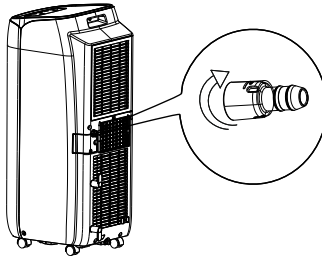

3. Insert the drainage hose into drain connector.

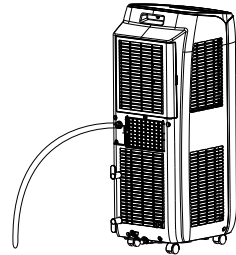

ATTENTION:

When using continuous drainage option from the middle hole, place portable on a level surface and make sure garden hose is clear of any obstructions and is directed downward. Placing portable on an uneven surface or improper hose installation may result in water filling up the chassis and causing the unit to shut off. Empty water in the chassis if shut off occurs, then check portable location and hose for proper setup.

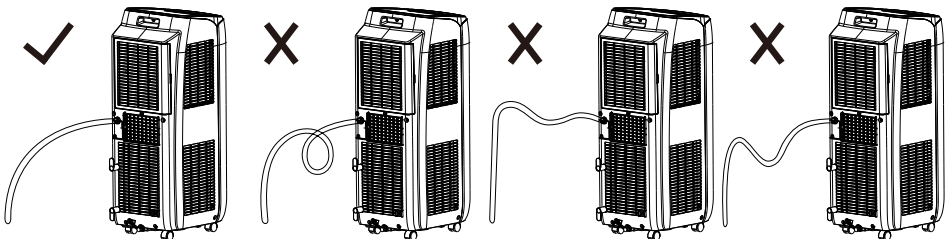

Installation in a double-hung sash window(Optional)

1. Connect the rain guards to the insect guard net.

Insert all three projections on each rain guard into the holes in the insect guard net. Side "A" will now be at the top, as indicated in the diagram.

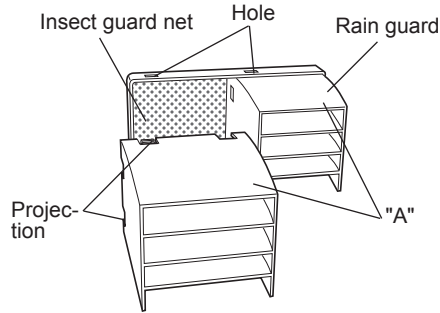

2. Attach the guard combined above to the window panel.

Push the insect guard net firmly to ensure that its four projections fit into the holes in the window panel.

Side "A" will now be at the top, as indicated in the diagram.

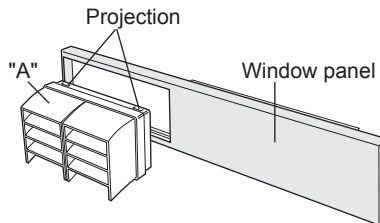

3. Cut the Foam seal B (adhesive type) to the proper length and attach it to the window stool and to the bottom of sash.

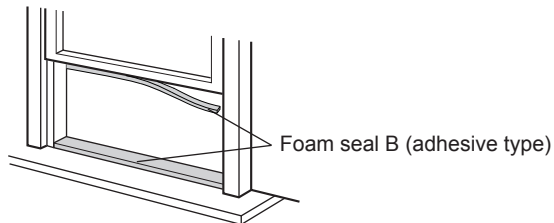

4. Attach the window panel to the window stool.

Make sure that the exhaust cover is attached to the window panel.

Inner width of the window:20.5"(520mm)

Use the window panel.

Installation in a double-hung sash window(Optional)

The window panel cannot be installed in windows less than 20.5" (520mm) wide, as you will be unable to shut the exhaust cover.

- (1) Open the window sash and place the window panel on the window sill.
- (2) Secure the window panel to the window stool with screws.

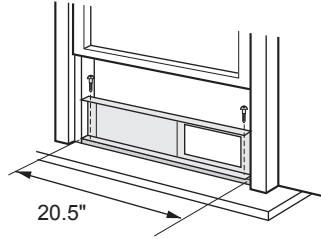
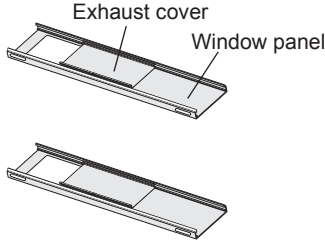

Inner width of the window: 20.5" (520mm) - 37.4" (950mm)

Use the window panel and the adjustment panel.

- (1) Open the window sash and place the window panel on the window sill.
- (2) Slide the adjustment panel to fit the window frame width.
- (3) Secure the window panel to the sill with screws.

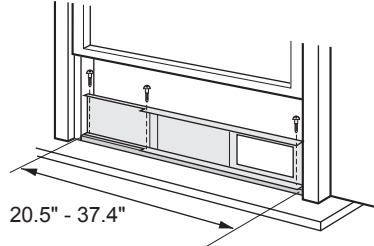
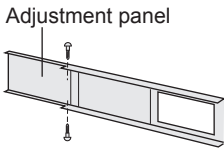

Inner width of the window: 37.4" (950mm) - 56.7" (1440mm)

Use the window panel, the adjustment panel and the extension panel.

- (1) Open the window sash and place the window panel on the window sill.
- (2) Slide the adjustment and extension panels to fit the window frame width.
- (3) Secure the window panel to the window sill with screws.

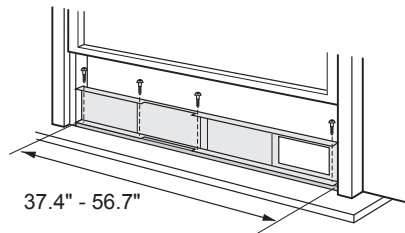
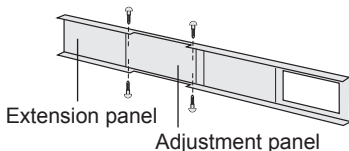

Installation in a double-hung sash window(Optional)

5. Close the window sash securely against the Window panel.

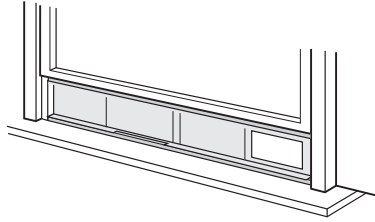

6. Stuff the Foam seal A between the glass and the window to prevent air and insects from getting into the room.

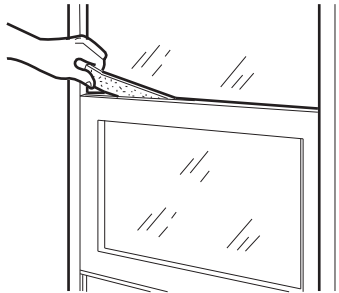

7. Attach the bracket with a screw.(Recommended)

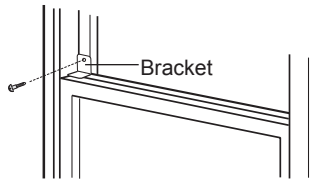

Please lay a tabular material underneath the window panel in case you could not attach the rain guard or the window adapter properly due to the deep window sill.

Installation in a sliding sash window(Optional)

1. Connect the rain guards to the insect guard net.

Insert all three projections on each rain guard into the holes in the insect guard net. Side "A" will now be at the top, as indicated in the diagram.

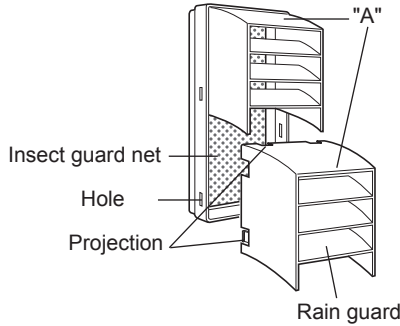

2. Attach the guard combined above to the window panel.

Push the insect guard net firmly to ensure that its four projections fit into the holes in the window panel.

Side "A" will now be at the top, as indicated in the diagram, when it is installed in the window.

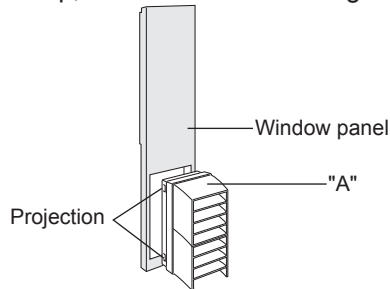

3. Cut the Foam seal B (adhesive type) to the proper length and attach it to the window frame and to the side of sash.

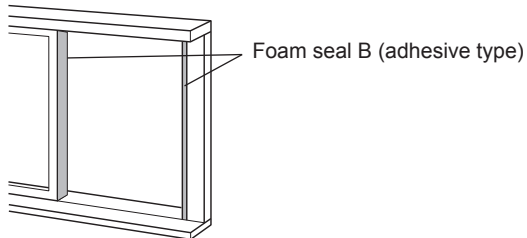

4. Install the window panel into the window frame.

Make sure that the exhaust cover is attached to the window panel.

Inner height of the window:20.5"(520mm)

Use the window panel.

Installation in a sliding sash window(Optional)

The window panel cannot be installed in windows less than 20.5" (520mm) high, as you will be unable to shut the exhaust cover.

- (1) Open the window sash and place the window panel on the window frame.
- (2) Secure the window panel to the window frame with screws.

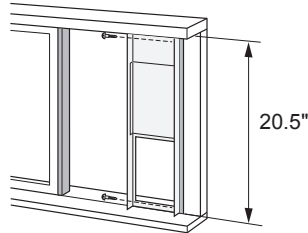
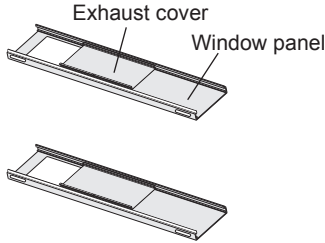

Inner height of the window:20.5" (520mm)- 37.4" (950mm)

Use the window panel and the adjustment panel.

- (1) Open the window sash and place the window panel on the window frame.
- (2) Slide the adjustment panel to fit the window frame height.
- (3) Secure the window panel to the window frame with screws.

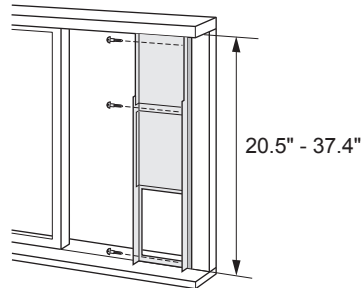
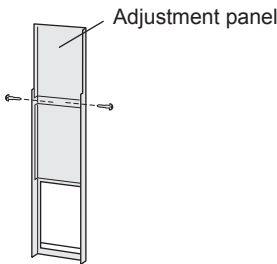

Inner height of the window:37.4" (950mm) - 56.7" (1440mm)

Use the window panel, the adjustment panel and the extension panel.

- (1) Open the window sash and place the window panel on the window frame.
- (2) Slide the adjustment and extension panels to fit the window frame height.
- (3) Secure the window panel to the window frame with screws.

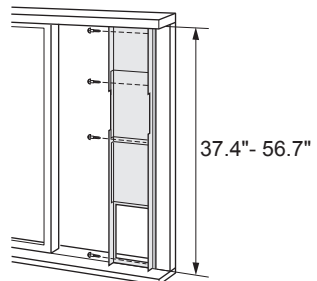
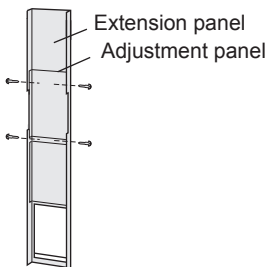

Installation in a sliding sash window(Optional)

4. Close the window sash securely against the Window panel.

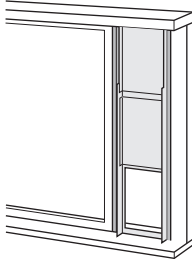

5. Stuff the Foam seal A between the glass and the window to prevent air and insects from getting into the room.

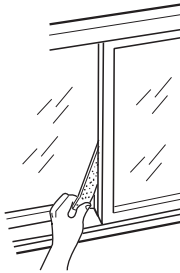

6. Attach the bracket with a screw.(Recommended)

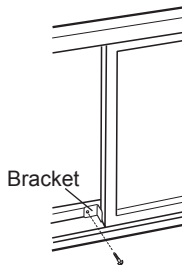

Please lay a tabular material underneath the window panel in case you could not attach the rain guard or the window adapter properly due to the deep window sill.

Installation and Disassembly of Heat Discharge Pipe

Install heat discharge pipe

1. Install window adapter— aim the window adapter(top) at the window adapter(bottom),fix them together,press the clasp forcibly into the groove.

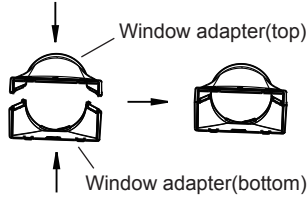

2. Rotate joint and window adapter clockwise into the two ends of heat discharge pipe.

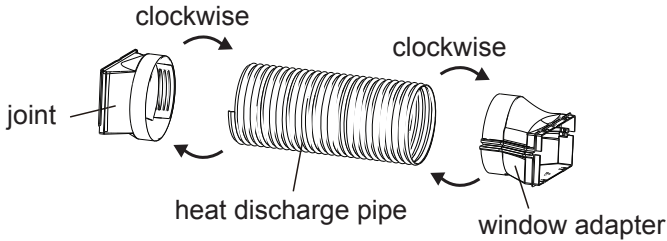

3. Insert joint of heat discharge pipe (the side with "TOP" is upwards) into the groove until you hear a sound.

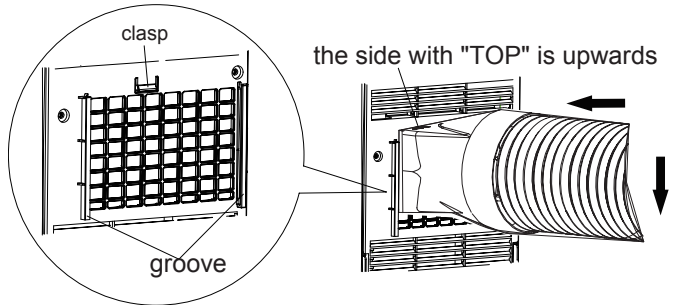

4. Lead the exhaust hose outdoors.

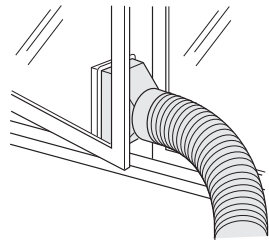

5. Slide and open the exhaust cover on the window panel, and attach the window adapter. (Optional)

Installation and Disassembly of Heat Discharge Pipe

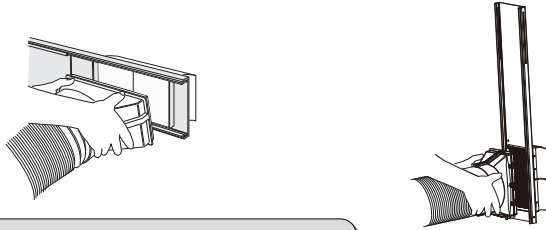

Note of Installing heat discharge pipe

In order to improve cooling efficiency, the heat discharge pipe should be as short as possible and flat without curve to ensure smooth heat discharge.

The discharge pipe is suggested to be installed according to below figure by the manufacturer.

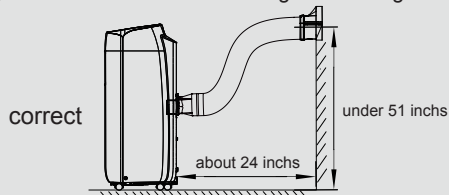

User can adjust the installation method of the discharge pipe basing on the requirement, while the similar installation methods as below which will lead to unsmoothly air-out are not allowed.

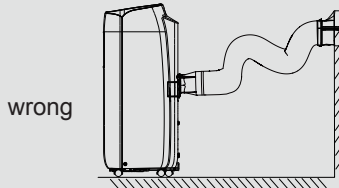

- The length of the heat discharge pipe is less than 40 inches. It is recommended to use it with shortest length.
- When installing, heat discharge pipe should be as flat as possible. Don't prolong the pipe or connect it with other heat discharge pipe.

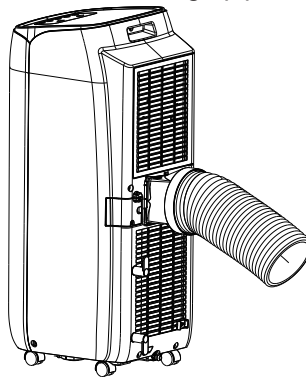

Installation and Disassembly of Heat Discharge Pipe

Disassemble heat discharge pipe

1. Remove joint:
Press the clasp and lift joint upwards to remove it.

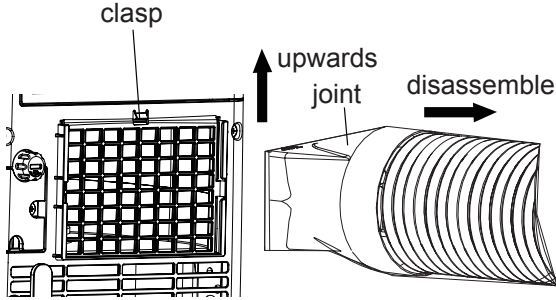

2. Remove window adapter from outdoors.

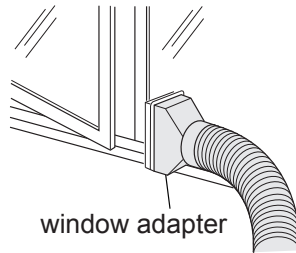

3. Remove the window adapter. Pull out and remove the window adapter by pushing down two "PUSH" markings, and slide and close the exhaust cover in the window panel. (Optional)

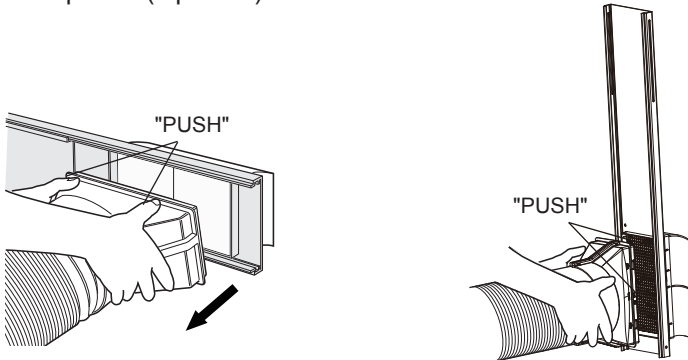

Operation Test

- Put through the power supply and then press ON/OFF button on remote controller to start the unit.
- Press mode button to select auto, cooling, drying, fan or heating function, and then check if the unit operates normally.
- If ambient temperature is below 16°C, the unit can't operate in cooling mode.

Electric Schematic Diagram

The Electric schematic diagram are subject to change without notice. Please refer to which one on the unit.

